

## Installation details for Bowfell Mountain multiplay (M101)

### Component list

1.2m H sections	2
Square platforms	1
1.2m slide, holder & foot	1
Access steps	1
Hoop Trapeze & Top	1
Firepole	1

- 1) Construct base as per layout drawing 1 ensuring the correct levels for safety surfacing.
- 2) Excavate 400mm x 400mm holes for H sections as in drawing 2 to a depth of 450mm from finished surfacing level. (All H sections have finished ground level marks)
- 3) Connect the H sections to the platforms and place into the excavated holes.
- 4) When all H sections and links have been fitted, level in all directions and check distances from edge of surfacing area.
- 5) Mark out for access points as drawing 3 and excavate to a depth of 450 as before (550mm for the slide foot)
- 6) Assemble all other items of equipment as drawing using M10 x 30 resistorx & nylon washers.
- 7) Note: M10 x 25 resistorx are used to connect the slide to the foot.
- 8) Once all equipment is fitted check levels again, tighten all bolts & concrete in to the ground.

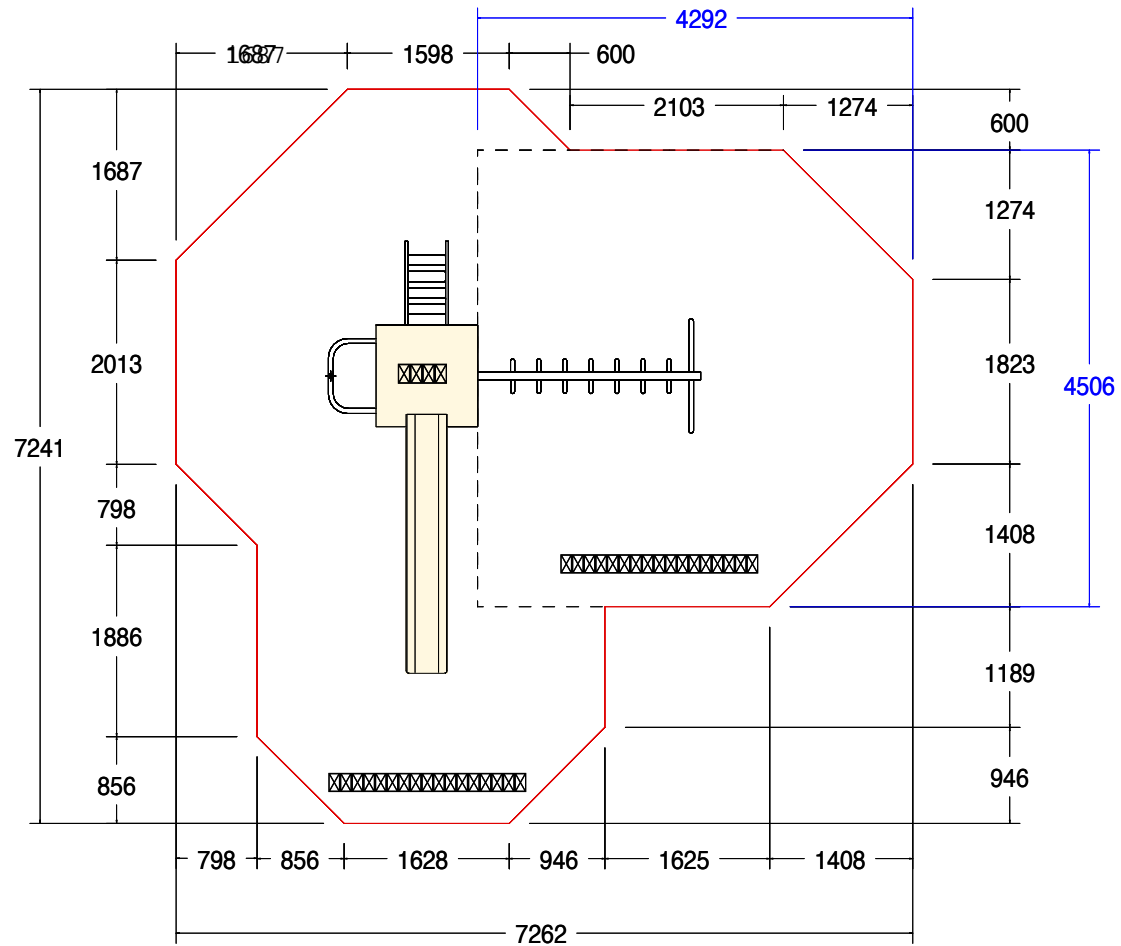

DESCRIPTION <b>BOWFELL - BASE LAYOUT</b>			
SCALE	<b>NTS</b>	DATE	<b>22/02/13</b>
		DRG. No.	<b>I-MO01-1</b>

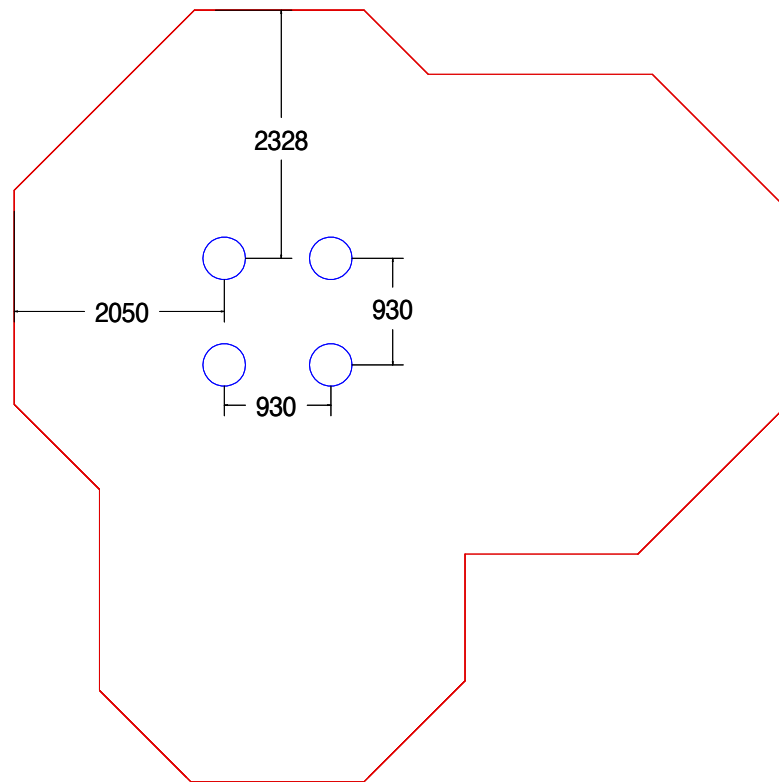

DESCRIPTION BOWFELL - H SECTION LAYOUT			
SCALE	NTS	DATE	22/02/13
		DRG. No.	I-M001-2

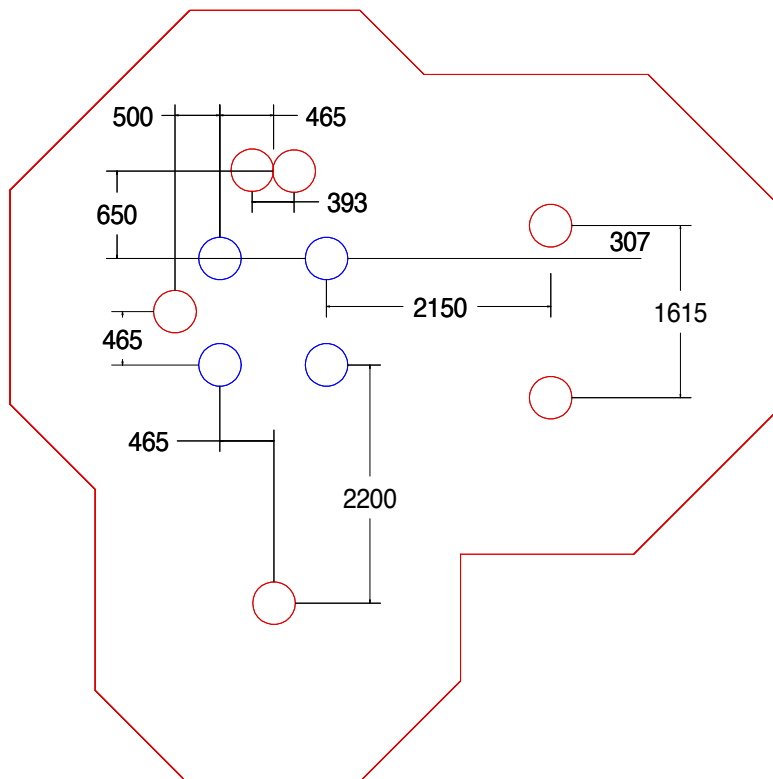

DESCRIPTION <b>BOWFELL - ACCESS POINTS LAYOUT</b>			
SCALE	<b>NTS</b>	DATE	<b>22/02/13</b>
		DRG. No.	<b>I-M001-3</b>

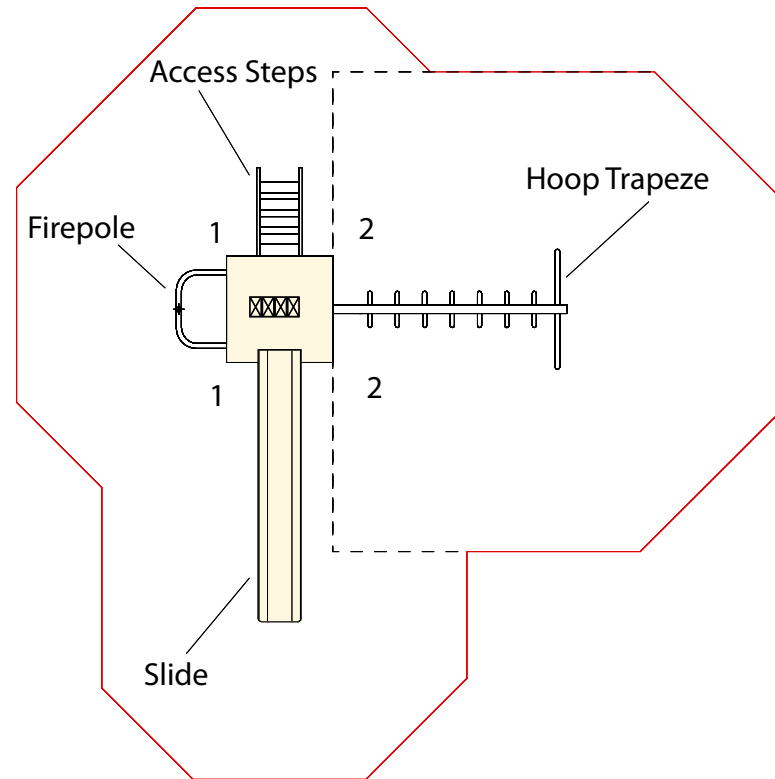

DESCRIPTION BOWFELL - EQUIPMENT LAYOUT			
SCALE	NTS	DATE	22/02/13
		DRG. No.	I-M001-4



✓ All Play & Leisure's product range is fully compliant with **BS EN 1176:2008**

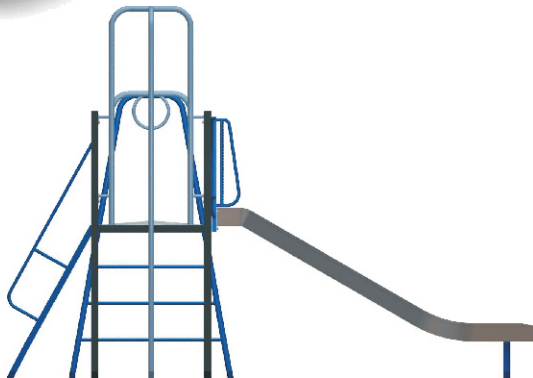

Side Elevation

## Features

- 1 Access Steps
- 2 Fireman's Pole
- 3 Stainless Steel Slide
- 4 Hoop Trapeze

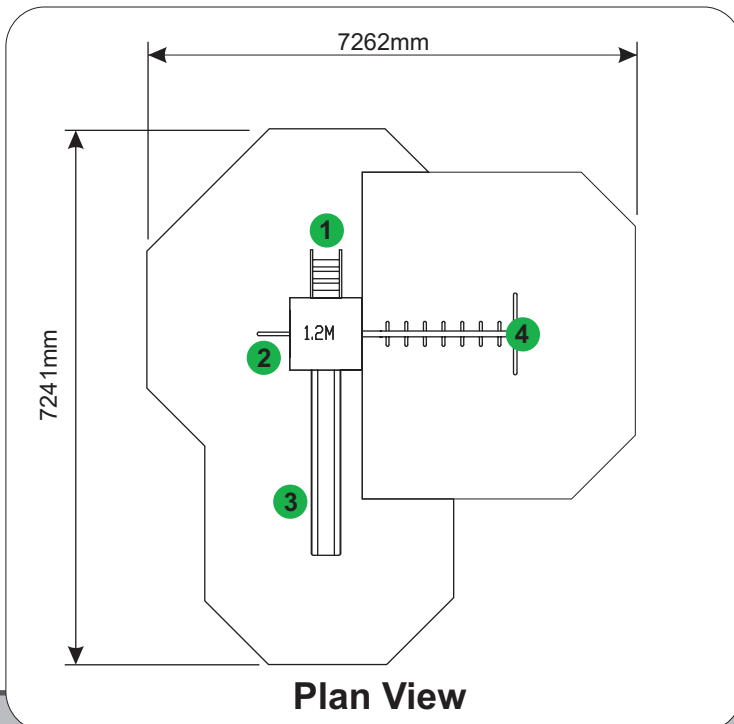

Plan View

## Technical AT-A-GLANCE

<b>Product Code</b>	M101
<b>Equipment Size</b>	4158L x 3582W x 3000H
<b>Minimum Space</b>	7262 x 7241
<b>Free Height of Fall</b>	1200 & 2300
<b>Safety Surface Area</b>	20m <sup>2</sup> & 16m <sup>2</sup>

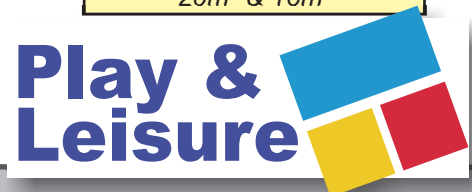

# **Maintenance Schedule**

## **Maintenance & Inspection**

All Play & Leisure's products should be inspected and maintained in accordance with the recommendations as detailed in BS EN 1176-7:2008

If any part of the equipment is found to be unsafe during an inspection and cannot be immediately rectified the equipment should be protected against further use.

## **Routine Visual Inspection.**

Routine visual inspections are to be conducted to identify obvious hazards resulting from vandalism, use or weather conditions. e.g. Hazards such as broken parts or broken bottles.

## **Operational Inspection.**

To reduce accidents the operator should ensure an appropriate routine maintenance schedule is established, implemented and maintained. Inspection shall be carried out on a monthly basis, although consideration should be taken regarding local conditions and usage.

During a operational inspection the following should be included:

- Tightening of fastenings.
- Re-painting and re-treatment of surfaces.
- Maintenance of any impact attenuating surfaces.
- Lubrication of bearings.
- Marking of equipment to signify loose fill finished surface levels.
- Cleaning.
- Removal of broken glass and other debris or contaminants.
- Restoring loose fills to the correct level.
- Maintenance of free space areas.

## **Annual Main Inspection (NOT EXCEEDING 12 MONTHS)**

Inspection intended to establish the overall level of safety of equipment, foundation and playing surfaces.

- Effects of weather.
- Rotting or corrosion.
- A change in the level of safety of the equipment as a result of repairs made, or of added or replaced components

## **One Post Equipment Maintenance.**

Special attention should be paid to the stability of products being of a one post design.

## **Corrective Maintenance.**

Corrective maintenance should include measures to correct defects, or to establish the necessary levels of safety of the playground equipment and surfaces. Such measures should include:

- Replacement of fastenings.
- Welding or welding repairs.
- Replacement of worn or defective parts.
- Replacement of defective structural components.

## **Equipment Alterations.**

Alterations to parts of any products that could affect the essential safety of the equipment should only be carried out after consultation with Play and Leisure.

## **Equipment Identification**

Information regarding the manufacturer, I.D. Number, year of manufacturer and the European Standard is displayed on an identification plaque.